

Waves API 2500

User Manual



TABLE OF CONTENTS

CHAPTER 1 – INTRODUCTION.....	3
1.1 WELCOME.....	3
1.2 PRODUCT OVERVIEW	4
1.3 CONCEPTS AND TERMINOLOGY	5
1.4 COMPONENTS.....	8
CHAPTER 2 – QUICKSTART GUIDE	9
CHAPTER 3 – CONTROLS AND INTERFACE.....	10
3.1 COMPRESSOR SECTION.....	10
3.2 TONE SECTION	12
3.3 LINK SECTION	13
3.4 METER DISPLAY	14
3.5 OUTPUT SECTION.....	15
CHAPTER 4 – THE WAVESYSTEM	17
4.1 THE WAVESYSTEM TOOLBAR	17
<i>Toolbar Functions</i>	17
4.2 PRESET HANDLING.....	17
<i>Preset Types</i>	17
<i>Loading Presets and Setups</i>	18
<i>Saving Presets and Setups</i>	18
<i>Deleting Presets</i>	19
<i>A/B Comparison and Copying</i>	19
4.3 INTERFACE CONTROLS	19
<i>Toggle Buttons</i>	19
<i>Value Window Buttons</i>	20
<i>Sliders</i>	20
<i>Hover Box</i>	20
<i>Multiple Selection of Controls</i>	20
<i>TAB Functions</i>	20
APPENDIX A – API 2500 CONTROLS	22

Chapter 1 – Introduction

1.1 Welcome

Thank you for choosing Waves! In order to get the most out of your Waves processor, please take the time to read through this manual.

In conjunction, we also suggest that you become familiar with www.wavesupport.net. There you will find an extensive **Answer Base**, the latest **Tech Specs**, detailed **Installation** guides, new **Software Updates**, and current information on **Authorization** and **Registration**.

By signing up at www.wavesupport.net, you will receive personalized information on your registered products, reminders when updates are available, and information on your authorization status.

1.2 Product Overview



The API 2500 is a versatile dynamics processor that lets you shape the punch and tone of mixes with absolute accuracy. Its dual channel design lets the 2500 also function as two separate mono channels via a single compression setting. Using auto-makeup gain, you can adjust Threshold or Ratio while automatically maintaining a constant output level. With both Feed Back and Feed Forward compression types, the API 2500 boasts a wide range of incredibly musical parameters which have made it a favorite of engineers the world over.

1.3 Concepts and Terminology

There are 3 main parameters that set the API 2500 from other compressors: Thrust, Compression Type, and its adjustable Knee. When used in conjunction with one another, these parameters give the API 2500 unprecedented flexibility.

Knee

Sets the knee, the manner in which the compressor begins to reduce the gain of the signal.

- In the **Hard** position, gain reduction begins immediately at the set ratio.
- In the **Med** position, there is a slight fade-in to the set ratio.
- In the **Soft** position, there is an even more gradual fade-in to the set ratio.

Compression KNEE at the Threshold Point

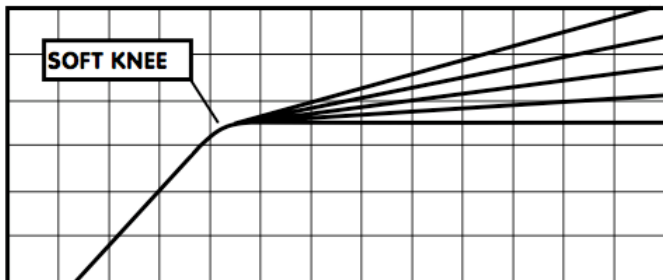
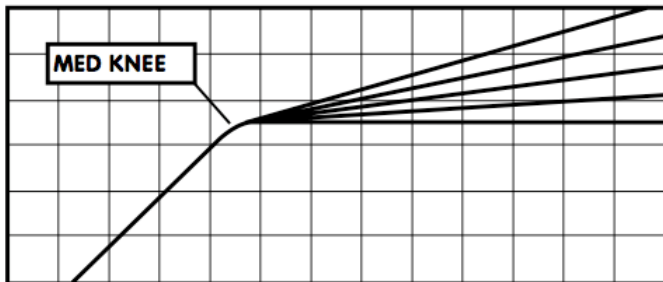
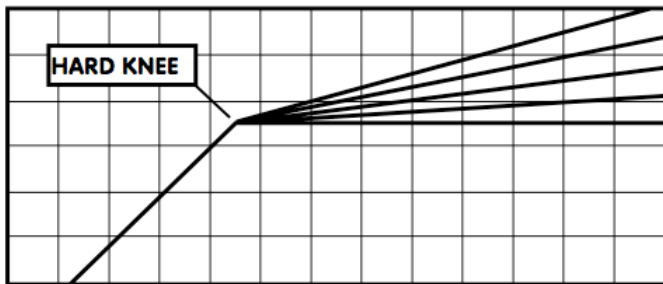

Thrust

Sets the Thrust, a proprietary process that inserts a High Pass Filter at the RMS detector input, limiting compression response to lower frequencies while applying additional compression to higher frequencies.

- In **Norm** mode, there is no filter and the 2500 functions like a normal compressor.
- In **Med** mode, there is a slight attenuation of the low frequencies and a slight boost of the high frequencies, with a flat mid range affecting the signal into the RMS detector. This reduces pumping caused by low frequencies and increases the RMS detectors' sensitivity to higher frequencies, affecting higher frequency signal peaks.
- In **Loud** mode, a gradual linear filter attenuates level by 15dB at 20hz and increases level by 15dB at 20khz. This decreases low frequency pumping while increasing higher frequency compression.

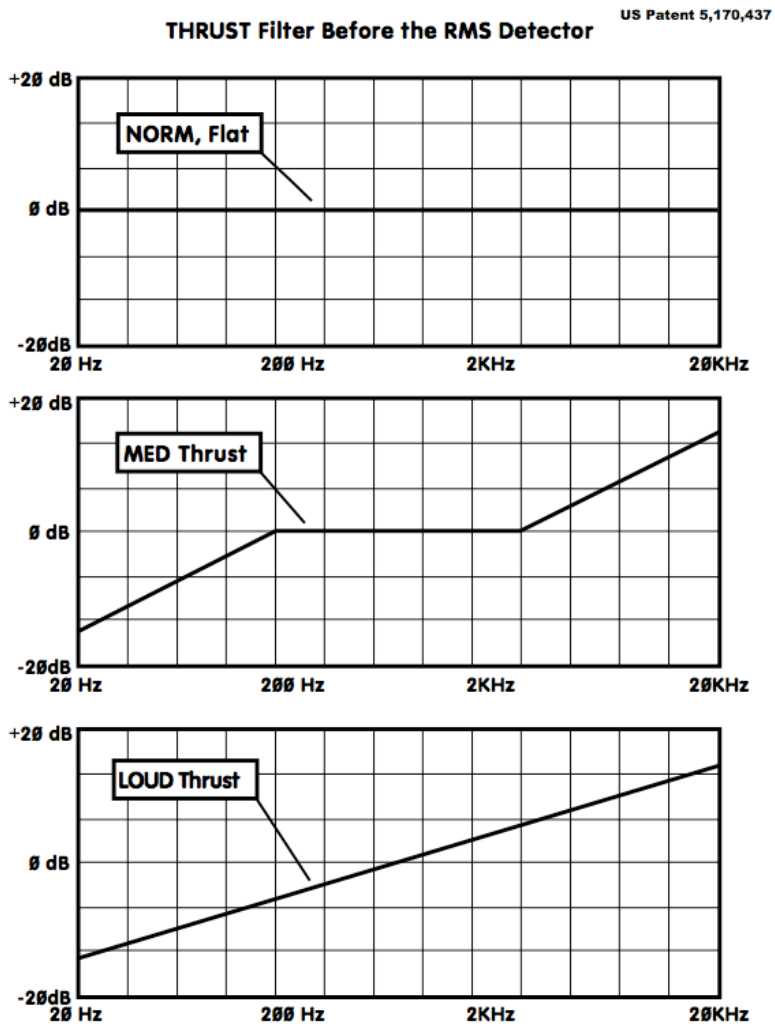

Type

Sets the Compression type, which determines the signal source being fed to the RMS detector.

- In **New** (Feed Forward) mode, the compressor works like newer VCA-based compressors. The RMS detector sends a signal to the VCA that is an exact ratio of the desired compression, set by the ratio control.
- In **Old** (Feed Back) mode, the RMS detector receives a signal from the VCA output, and then feeds the VCA a signal based on the set signal ratio.

"NEW" or FEED FORWARD type COMPRESSION

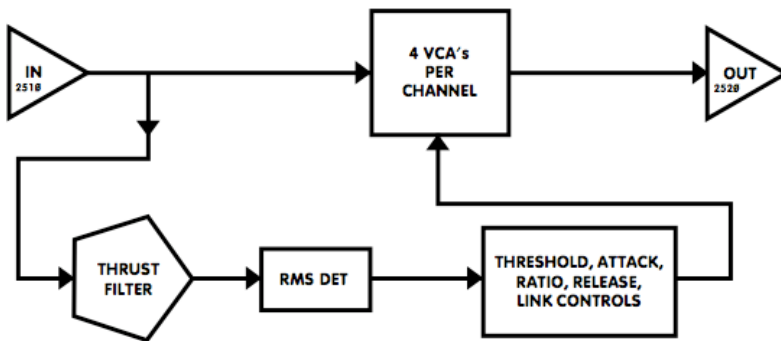

"OLD" or FEED BACK type COMPRESSION

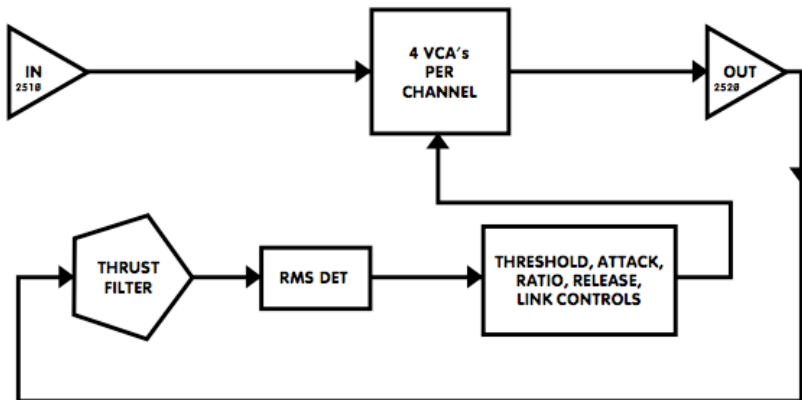

1.4 Components

WaveShell technology enables us to split Waves processors into smaller plug-ins, which we call **components**. Having a choice of components for a particular processor gives you the flexibility to choose a configuration suitable for your material.

The API 2500 has two component processors:

API 2500 Stereo – A stereo compressor that may also be used as two parallel mono processors.

API 2500 Mono – A mono compressor with an external sidechain option.

Chapter 2 – Quickstart Guide

For those of you who are experienced users of audio signal processing tools, we recommend that you approach the API 2500 as you would any compressor which you are already familiar. Keep in mind that its Thrust, Compression Type, and Knee parameters offer capabilities that transcend other, more conventional, processors.

Newer users should explore the API 2500's preset library and use its presets as starting points for their own experimentation. These presets also serve as a valuable introduction to compression techniques in general, and offer a glimpse into the workflow of professional audio engineers.

We encourage all users to experiment with the API 2500's settings in order to better understand its unique processing power.

Chapter 3 – Controls and Interface



3.1 Compressor Section



Threshold

Sets the point at which compression begins. Threshold for each stereo channel is set independently, since each channel has its own RMS detector, even in Link mode. In Auto Gain Make-up mode, the Threshold also affects the gain. Threshold is a continuous control.

Range

+10dBu to -20dBu (-12dBFS to -42dBFS)

Default

0dBu

Attack

Sets the attack time of each channel.

Range

.03ms, .1ms, .3ms, 1ms, 3ms, 10ms, 30ms

Default

1ms

Ratio

Sets the compression ratio of each channel. In Auto Gain Make-up mode, Ratio also affects the gain.

Range

1.5:1, 2:1, 3:1, 4:1, 6:1, 10:1, inf:1

Default

4:1

Release

Sets the Release time of the compressor. When set to Variable, Release time is controlled by the Variable Release control, located to the right of the Release control.

Range

.05sec, .1sec, .2sec, .5sec, 1sec, 2sec, Variable

Default

.5sec

Variable Release

Controls the release time with a continuously variable knob. (Please note: Release control must be set to Variable.)

Range

.05 seconds to 3 seconds in steps of 0.01ms

Default

.5sec

3.2 Tone Section



Knee

Sets the Knee, the manner in which the compressor begins to reduce the signal gain.

Range

Hard, Med, Soft

Default

Hard

Thrust

Sets the Thrust, a proprietary process that inserts a High Pass Filter at the RMS detector input, limiting compression response to lower frequencies while applying additional compression to higher frequencies.

Range

Loud, Med, Norm

Default

Norm

Type

Sets the Compression type, which determines the signal source being fed to the RMS detector.

Range

Feed Back, Feed Forward

Default

Feed Forward

A note about Sidechain:

Sidechain lets you trigger the compressor using an external source, which is fed into the RMS detector and controls the compression of the input signal. Sidechain may only be used in New (Feed Forward) mode. An external sidechain trigger cannot be used in Old (Feed Back) mode; attempting to do so automatically switches the compressor to New (Feed Forward) mode.

3.3 Link Section



L/R Link

Sets the percentage of linkage between the left and right channels. While in Link mode, each channel is still controlled by its own RMS detector, which prevents loading and slaving from either side.

Range

IND, 50%, 60%,70%,80%,90%,100%

Default

100%

Shape

Adjusts the Shape of the link control voltage mixing. The HP (high pass filter, LP low pass filter eliminating the highs and a combination of both filters creating a band pass filter. the value of this circuit allows the Link control voltage to not include certain frequencies. Different filter combinations can be used, for example, to prevent percussive instruments on one channel from coupling and causing unwanted compression on the other channel.

Range

HP, LP, BP, Off

Default

Off

3.4 Meter Display



Meters

The API 2500's Meters display dBFS. The Gain scale displays the amount of gain reduction during compression with the 0 point located at the far the right, which allows higher gain reduction scale resolution.. The API 2500 is capable of up to 30dB of reduction.

Range

0dB to -24dB (Gain Reduction mode)

-24dB to 0dB (Input and Output modes)

Switchable Display Modes

Range

GR, Out, In

Default

GR

Clip LED

Between the two Meters is a Clip LED which indicates input or output clipping. Since the LED shows both input and output clipping, you must determine which of the two levels is excessive. The Clip LED can be reset by clicking on it.

3.5 Output Section



Analog

Turns the Analog modeling on and off.

Range

On/Off

Default

On

Output

Controls the output level in 0.1dB steps

Range

+/-24dB

Default

0dB

Make-Up

Turns Auto Make-Up Gain on and off.

Range

Auto, Manual

Default

Auto

In

Acts as a master bypass for the entire compression chain. When set to Out, all compressor functions are bypassed.

Range

In/Out

Default

In

Chapter 4 – The WaveSystem

4.1 The WaveSystem Toolbar

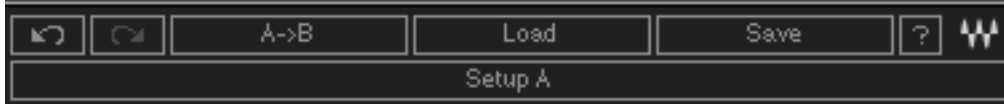

All Waves processors feature the WaveSystem toolbar which takes care of most administrative functions you will encounter while working with your Waves software. The features of the WaveSystem toolbar are the same on practically all Waves processors, so familiarity with its features will be helpful whichever processor you are using.

Toolbar Functions

Undo	Undoes the last 32 actions.
Redo	Redoes the last 32 undone actions.
Setup A/B	Toggles between two presets. This is useful for close comparison of different parameter settings
Copy A->B	Copies the current settings to the second preset register
Load	Recalls presets from file
Save	Saves presets in the Waves file formats
?	Opens the manual for the processor you are using

4.2 Preset Handling

Preset Types

Factory Presets are permanent presets in the Load menu. Factory presets cannot be over-written or deleted. When applicable, different component plug-ins may have different factory presets.

User Presets are your favorite settings of the plug-in saved as a preset in the Load menu, under 'User Presets'. User Presets can be over-written and deleted.

Setup Files may contain more than one preset. For example, a single file can contain all the presets for a session. When you open a Setup File, all its setups become part of your Load pop-up menu for fast access. This can be particularly useful with multiple instances of a plug-in in a single session. By saving all the settings you create into a single Setup File, they can all be quickly available for every instance of that plug-in.

Loading Presets and Setups



Click-and-hold on the Load button to see the Load pop-up menu. The menu is divided into four sections. If a section is not currently available it will not appear in the Load pop-up menu.

- Open Preset File...** Select to open any setup or preset file, whether from the Library or your own creations.
- 'Filename.xps':** Displays any currently loaded Setup File and its presets.
- Factory Presets:** Displays the default Factory Presets.
- User Presets:** Displays any loaded User Presets.

Saving Presets and Setups



Click-and-hold on the Save button to see the Save pop-up menu. Four options are available. If an option is not currently available it will be grayed out and inaccessible.

- Save to New File...** Select this to start a new Setup file. There are two prompts - first for the setup filename, then for the preset name. You must provide a name for both the setup file and the preset. Click OK (ENTER) to complete the save. It is a good idea to create a folder in which to save several setup files for a project.
- Save 'File Name' – "Preset Name"** Overwrites the settings of the loaded preset (whether a User Preset or a preset from a Setup File) with the current settings. If a Setup File is currently loaded, the name of the Setup File is displayed followed by the name of the preset itself. If a User Preset is loaded, its name is displayed.
- Save to 'File Name' As...** Saves the current settings as a new preset into the Setup file that is open (if one is not open, the option is grayed out). You will be prompted to give the preset a name.
- Put into Preset Menu As...** Save the current settings into a User Preset that will always be in your Load menu (until deleted). You will be prompted to give this preset a name. User Presets are stored in the plug-in's preference file.

Deleting Presets

You may delete User Presets and presets within a Setup File. Factory Presets and Setup Library files cannot be deleted or overwritten.

1. Hold the Command (Mac)/Control (PC) key down.
2. Click-and-hold the Load button to see the pop-up menu.
3. While still holding the Command/Control key, select the preset or setup to delete.
4. A confirmation box will appear, allowing you to cancel or 'OK' the deletion.

A/B Comparison and Copying

The Setup A/Setup B button may be clicked to compare two settings. If you load a preset in the Setup B position, this will not affect the preset loaded into the Setup A position, and vice-versa.

If you want to slightly modify the settings in Setup A, you can copy them to Setup B by clicking on the Copy to B button, then alter Setup A and compare with the original Setup B.

The name of the current setup will be shown in the title bar (on platforms which support it), and will switch as you change from Setup A to Setup B.

Note: an asterisk will be added to the preset name when a change is made to the preset -

4.3 Interface Controls

Controls can be in one of three states:

- **Not Selected** where the control is not the target of any user entry
- **Selected** where the control is the target of mouse control entry only
- **Selected and Active** where the control is the target for both mouse and keyboard entry

Toggle Buttons

Toggle buttons display the state of a control, and allow switching between two or more states. **Single-click** to change the control's state. Some toggle buttons have a text display which updates with the current setting, and others (bypass, solo, or monitoring toggles) illuminate when the control is active.

Some processors have **link buttons** between a pair of toggle buttons, allowing click-and-drag adjustment while retaining the offset between the controls.

Value Window Buttons

Value windows display the value of a control and allow **click-and-drag** adjustment, or **direct control via the keyboard**.

- **Using the mouse**, click-and-drag on the value window to adjust. Some value windows support left/right, some up/down (as you hover over a button, arrows will appear to let you know which direction of movement that button supports).
- **Using the arrow keys**, click once with mouse to select the button, and then use up/down – left/right (depending on the direction supported by that button) to move in the smallest incremental steps across the button's range (holding down the arrow keys will move faster through the range).
- **Using key entry**, double click on the button to open the value window, and directly enter the value from your keyboard. If you enter an out of range number, the button stays selected but remains at the current setting (system beeps? If system sounds are on?)

Some processors have **link buttons** between a pair of value windows, allowing click-and-drag adjustment while retaining the offset between the controls.

Sliders

Click on the slider itself or anywhere within the sliders track. The numerical value of the slider settings is displayed in a hover window above the slider path.

Hover Box

Hovering boxes will appear and display the control value when hovering with the mouse over the control.

Multiple Selection of Controls

One of the most powerful features of the WaveSystem is the ability to select and adjust many controls at the same time. Using the mouse, simply drag-select the desired group of button or graphic controls by clicking and holding at a point outside the controls and forming a rectangle to include the controls you wish to adjust. Alternatively, you can hold down Shift while clicking the mouse on any control you wish to link. This second method is useful when you want to select two (or more) controls that are separated on the GUI by other controls you do not wish to select.

TAB Functions

TAB moves the 'selected' status to the next control, with shift-TAB moving in the reverse direction.

Additionally, the Mac has an option-TAB function for 'down' movement and shift-option-TAB for 'up' movement where applicable.

If you have several Value Window Buttons selected, TAB functions will take you through the selected controls only.

Appendix A – API 2500 Controls

Control	Range	Default
Threshold	+10dBu to -20dBu	0dBu
Attack	.03ms, .1ms, .3ms, 1ms, 3ms, 10ms, 30ms	1ms
Ratio	1.5:1, 2:1, 3:1 4:1 6:1 10:1 inf:1	4:1
Release	.05sec, .1sec, .2sec, .5sec, 1sec, 2sec, Var	.5sec
Release Variable	.05 to3sec in steps of 0.01ms	.5sec
Knee	Hard, Med, Soft	Hard
Thrust	Loud, Med, Norm	Norm
Type	FeedBack, Feed forwards	Feed Forwards
L/R Link	IND, 50%,60%,70%,80%,90%,100%	100%
Link Filter	Off, HP, LP, BP	Off
Make-up	Auto, Manual	Auto
Meter	GR, OUT, IN	GR
Analog	On/Off	0deg
In	In/Out	In
Output	+/-24dB	0dB